

## FK 3000-160-2

Traglast TL (capacity)	3000 kg
Nutzhub NH (effective stroke)	1600 mm
Hubzeit HZ (time up/down, with nominal load)	ca. 34 s
Motorleistung P (power)	ca. 2,9 kW
Betriebsspannung/Frequenz $U_b/f$ (operating voltage/frequency)	400 V / 50 Hz
Aggregatposition (position of drive unit)	innen (inboard) <input type="checkbox"/> außen (outboard) <input type="checkbox"/>
Farbe (colour)	Hammerschlag silber (hammer finish silver)

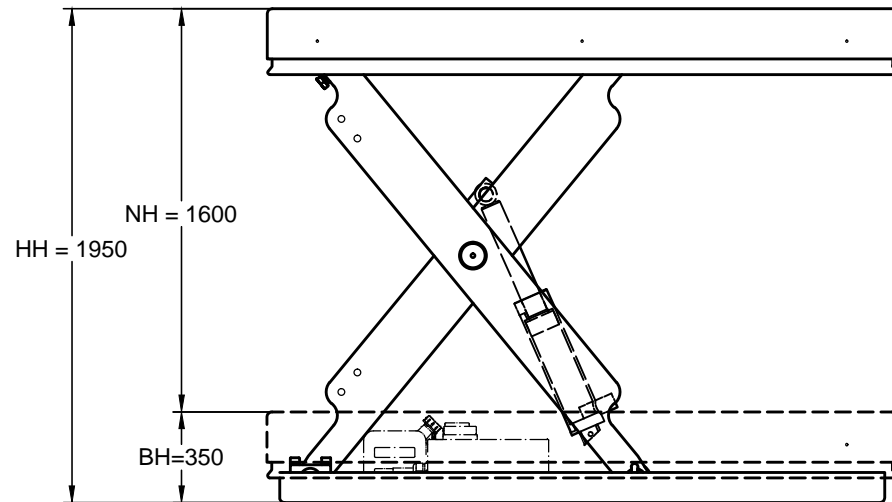

Alle Maße in mm!  
(all dimensions in mm)

HH: Hubhöhe (max. height)  
NH: Nutzhub (effective stroke)  
BH: Bauhöhe (min. height)

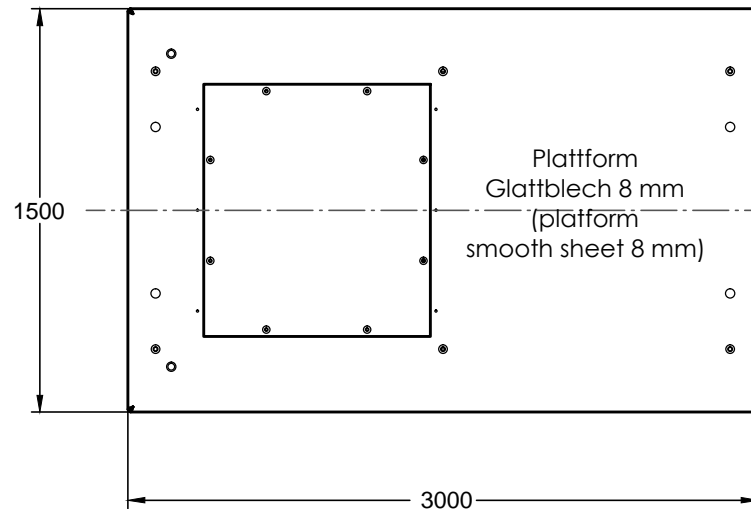

Unterrahmen nicht selbsttragend  
(non-self-supporting base frame)

