

FK 2000-100-1

Traglast TL (capacity)	2000 kg
Nutzhub NH (effective stroke)	1000 mm
Hubzeit HZ (time up/down, with nominal load)	ca. 28 s
Motorleistung P (power)	ca. 2,9 kW
Betriebsspannung/Frequenz U_b/f (operating voltage/frequency)	400 V / 50 Hz
Aggregatposition (position of drive unit)	innen (inboard) <input type="checkbox"/> außen (outboard) <input type="checkbox"/>
Farbe (colour)	Hammerschlag silber (hammer finish silver)

HH: Hubhöhe (max. height)

NH: Nutzhub (effective stroke)

BH: Bauhöhe (min. height)

Alle Maße in mm!
(all dimensions in mm)

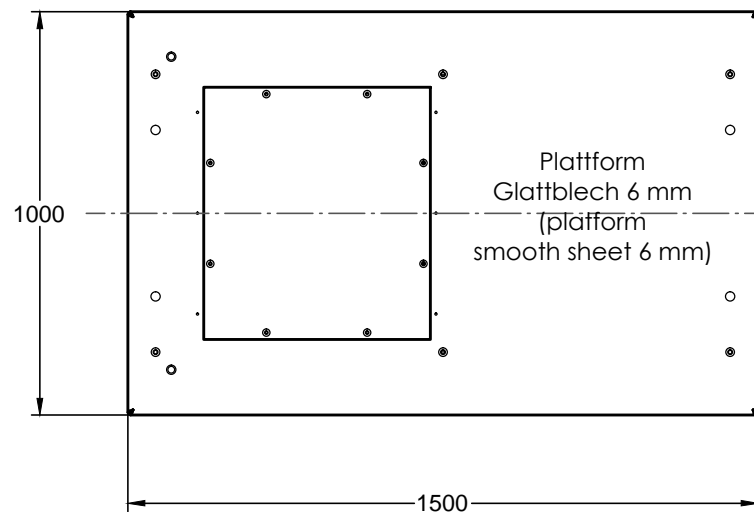
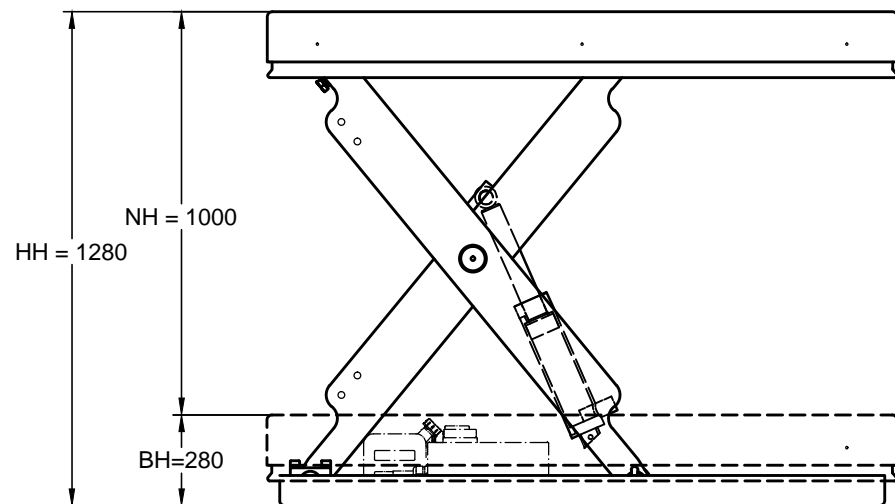

Unterrahmen nicht selbsttragend
(non-self-supporting base frame)

