

FK 1000-80-2

Traglast TL (capacity)	1000 kg
Nutzhub NH (effective stroke)	800 mm
Hubzeit HZ (time up/down, with nominal load)	ca. 14 s
Motorleistung P (power)	ca. 2,3 kW
Betriebsspannung/Frequenz U_b/f (operating voltage/frequency)	400 V / 50 Hz
Aggregatposition (position of drive unit)	innen (inboard) <input type="checkbox"/> außen (outboard) <input type="checkbox"/>
Farbe (colour)	Hammerschlag silber (hammer finish silver)

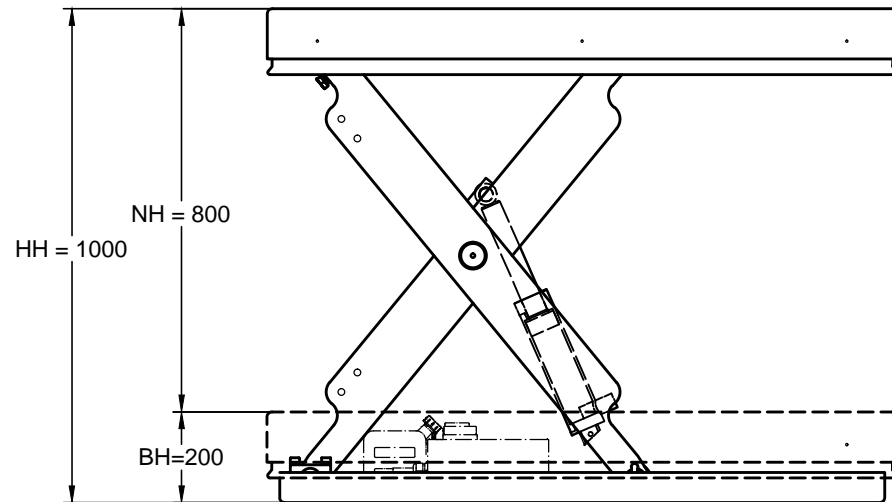

HH: Hubhöhe (max. height)
 NH: Nutzhub (effective stroke)
 BH: Bauhöhe (min. height)

Alle Maße in mm!
 (all dimensions in mm)

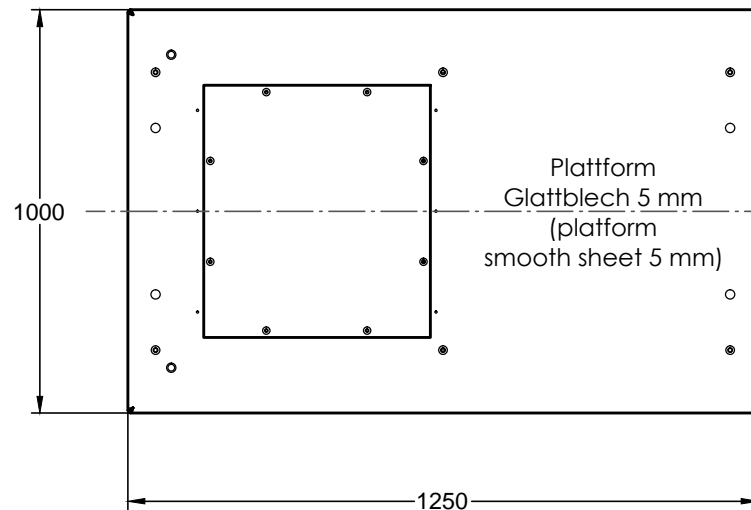

Unterrahmen nicht selbsttragend
 (non-self-supporting base frame)

